

Thermospray Interface for Liquid Chromatography/Mass Spectrometry

C. R. Blakley and M. L. Vestal*

Department of Chemistry, University of Houston, Houston, Texas 77004

The latest version of the thermospray LC/MS interface has been installed on a Biospect quadrupole mass spectrometer. This interface requires only minor modification of the commercial instrument with a single mechanical vacuum pump required in addition to the pumping system normally used for CI operation. It appears that this LC interface can readily be adapted to other quadrupole mass spectrometers. LC effluents are thermosprayed directly into the ion source and the excess vapor pumped away by the added mechanical pump which is directly coupled to the ion source through a port opposite the electrically heated thermospray vaporizer. This system provides stable vaporization and ionization at flow rates up to 2 mL/min of aqueous mobile phase. When used with mobile phases containing significant concentration of ions in solution (ca. 10^{-4} to 1 M) no external ionizing source is required to achieve detection of many nonvolatile solutes at the subnanogram level. With weakly ionized mobile phases a conventional electron beam is used to provide gas-phase reagent ions for chemical ionization of solute molecules.

During the past decade several laboratories have worked on the development of combined LC/MS systems; the results of these efforts have been amply reviewed (1, 2). Much of this work has focused on dealing with the fact that the mass flows involved in conventional HPLC (ca. 1 g/min) are 2 or 3 orders of magnitude larger than can be accommodated by conventional mass spectrometer vacuum systems. The status of various approaches to overcoming the apparent incompatibility between liquid chromatography and mass spectrometry has recently been summarized by Arpino (3, 4).

Our original approach to LC/MS employed laser heating to rapidly vaporize both the solvent and sample and molecular beam techniques to transport and ionize the sample while minimizing contact of the sample molecules with solid surfaces (5). The original apparatus used a large and expensive vacuum system and a 50-W CO₂ laser. Later we developed a greatly simplified version of this system by using oxy-hydrogen flames to vaporize the LC effluent and a substantially less elaborate vacuum system (6).

The earlier systems were designed to efficiently transfer the sample to either an electron impact (EI) or chemical ionization (CI) source while vaporizing and removing most of the solvent. In the latter version more than 50% of the sample was transferred to the CI ion source with only about 5% of the solvent vapor. This system gave satisfactory performance for a number of relatively nonvolatile samples and was used successfully with reversed-phase separations employing aqueous buffers at flow rates as high as 1 mL/min. The major problem with this system was that the vaporizer was difficult to control properly which often caused uncontrolled fluctuations in performance and some times frustrated attempts at application of the system to real analytical problems.

In the course of this work it was found that, under certain conditions, ions were produced even though the hot filament normally used to produce the primary ionizing beam was

turned off (7). Initial measurements of mass spectra produced from nonvolatile compounds such as peptides, nucleosides, and nucleotides showed that the spectra were quite different from those obtained by chemical ionization and were, in fact, most similar to those obtained by field desorption.

Our recent efforts have focused on developing an electrically heated vaporizer which would allow more precise control of the solvent vaporization. This has recently been accomplished; the present version allows the stable vaporization of virtually any solvent including aqueous buffers at flow rates up to at least 2 mL/min. The use of this electrically heated vaporizer has greatly improved the stability and reproducibility of the vaporization of solvents and nonvolatile samples and it is now possible to predict with confidence the conditions appropriate for a particular solvent composition and flow rate. The availability of a stable, reproducible vaporizer has also allowed more definitive studies of the vaporization and ionization mechanisms to be conducted. The results of these studies have led to some further modifications of the apparatus which both improve the performance and further simplify the construction. The present system is readily adapted to any commercial quadrupole mass spectrometer equipped with a vacuum system suitable for CI operation. The only addition to the vacuum system is a single stage mechanical vacuum pump of moderate capacity (ca. 300 L/min).

Initially we used the electrically heated vaporizer with differential pumping of the vaporizer housing, but more recently we have obtained improved performance by vaporizing the total LC effluent directly into the ion source with the mechanical vacuum pump connected opposite the vaporizer. With this system any solvent can be accommodated at flow rates up to 2 mL/min. It now appears that the apparent incompatibility between LC and MS has been successfully overcome and that a truly practical LC/MS has been developed.

EXPERIMENTAL SECTION

Apparatus. A schematic diagram of the "thermospray" system presently in use is shown in Figure 1. This interface and ion source are much simpler than the earlier versions and require only minor modification of a commercial quadrupole mass spectrometer. The present version of the vaporizer consists of a few centimeters of 0.015 mm i.d. by 1.5 mm o.d. stainless steel tubing (Handy and Harmon, Morris Town, PA) which is brazed at one end into a copper block. The block is heated by two commercial 100-W cartridge heaters (Watlow, St. Louis, MO) normally operated at substantially below their rated power. A thermocouple is imbedded in the copper block to monitor the temperature of the vaporizer and may be used in conjunction with a proportioning controller to maintain the temperature of the block constant. The length of tubing immersed in the block is not particularly critical, but lengths on the order of 3 cm are presently used. It is very important that the stainless tube be in good thermal contact with the copper block; the brazed joint is essential. The vaporizer produces a supersonic jet of vapor, normally containing a mist of fine particles or droplets. This jet traverses the ion source of the mass spectrometer and enters directly into a 1 cm diameter pumping line which is connected to a 300 L/min mechanical vacuum pump. Modifications to the ion source include the use of a conical ion exit aperture (as shown in Figure 1) and high

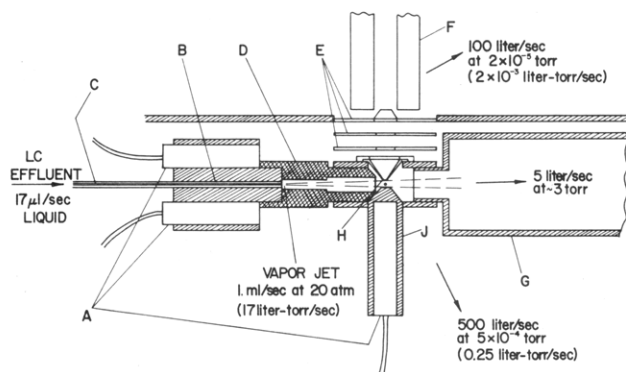

Figure 1. Schematic diagram of thermospray apparatus using electrically heated vaporizer: (A) 100-W cartridge heater; (B) copper block brazed to stainless steel capillary; (C) 1.5 mm o.d. \times 0.15 mm i.d. stainless steel capillary; (D) thick-walled copper tube; (E) ion lenses; (F) quadrupole mass filter; (G) pump out line to mechanical pump; (H) ion exit aperture; (J) source heater.

capacity source heater consisting of an 100-W cartridge heater imbedded in a copper rod which extends into the ion source cavity but does not intersect the main part of the jet. Except for the vaporizer, pump-out line, and source block, the thermospray LC/MS system is a commercial quadrupole mass spectrometer equipped for CI operation (Biospect, Scientific Research Instruments, Baltimore, MD).

At first it is somewhat surprising that this system can accommodate vaporizing up to 2 mL/min of liquid directly into the ion source without overloading the pumping systems since this corresponds to a gas flow which is about 100 times larger than that used with the mass spectrometer operated in the conventional CI mode. The addition of the mechanical vacuum pump connected directly to the source would only account for about 1 order of magnitude of increased capacity normally, but locating the pumping line directly opposite the thermospray vaporizer allows the supersonic jet to act as its own ejector pump. Thus the conductance of the pumping aperture is about 10 times as high as normal due to the highly directed flow of the jet. We have found that a 300 L/min mechanical pump is more than adequate to maintain stable performance at flow rates to 2 mL/min. It is essential that the pump be operated with gas ballast to avoid excess accumulation of liquid in the pump oil. Even then, it is important to service the pump frequently (usually daily) to drain out solvent and add pumping fluid.

RESULTS AND DISCUSSION

Design and Performance of the Vaporizer. The maximum velocity with which a superheated liquid may vaporize is given by

$$v_v = \left(\frac{m}{2\pi kT} \right)^{1/2} \frac{P_v(T)}{\rho L} \quad (1)$$

where $P_v(T)$ is the vapor pressure at temperature T , m is the molecular mass, ρ is the density of the liquid, k the Boltzmann constant, and L is Avogadro's number. For steady vaporization from the capillary nozzle the vaporization velocity given by (1) must be equal to the velocity of the liquid flow in the capillary tube. Assuming that sufficient heat is supplied, the pressure and temperature of the vapor emerging from a given diameter capillary nozzle are determined by (1) and the liquid flow rate. This relationship is illustrated for water vapor in Figure 2. At a flow rate of 1.0 mL/min of water through the 0.015 cm i.d. capillary presently in use, steady vaporization produces vapor at approximately 183 °C and at a pressure of about 10.5 atm. Measurement of liquid pressures and temperatures in the jet confirm that the behavior is approximately as predicted by the model.

In the thermospray vaporizer the temperature of the copper block coupling the heaters to the stainless steel capillary is monitored by a thermocouple. For stable operation it is es-

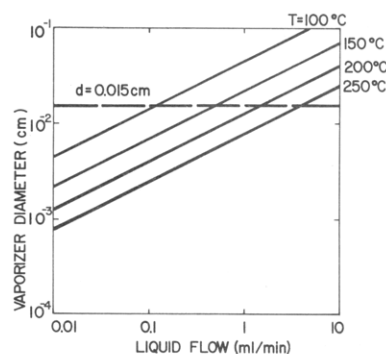

Figure 2. Relationship between vaporizer diameter and liquid flow rate for steady vaporization of water at the indicated vapor temperatures. The horizontal dashed line corresponds to the capillary nozzle used in the present work and the intersection with the isotherms gives the expected flow rate for steady vaporization at that temperature.

sential that good thermal contact be maintained between the copper block and the capillary; this is accomplished by brazing them together with a suitable silver alloy (e.g., 56% silver, cadmium free). The heat transfer from the copper block to the flowing fluid is then determined almost entirely by the temperature drop in the capillary tubing and at the solid-liquid interface. If the temperature were uniform over the length of the vaporizer, L , then for the cylindrical geometry used the resistance to heat flow is given by

$$R = \frac{1}{2\pi L} \left[\frac{\ln(b/a)}{k_s} + \frac{2}{nk_f} \right] \quad (2)$$

where a and b are the inner and outer diameter, respectively, of the capillary tube, k_s is the thermal conductivity of the stainless steel tube ($k_s = 0.16$ W/(cm °C)) and k_f is the thermal conductivity of the liquid (for water $k_f = 6 \times 10^{-3}$ W/(cm °C)), and n is the Nusselt number for the liquid solid interface (8). Equation 2 is a rather crude approximation to the actual case because, while the temperature of the outer surface is essentially constant over the length of the vaporizer, the temperature of the fluid varies along the length from that of the liquid at ambient to that of the vapor at the exit. In any case the heat flow, h , is related to the temperature drop between the copper block and the fluid by an equation of the form

$$h = (T - T_f)/R \quad (3)$$

where T is the temperature of the copper block and T_f is the average temperature of the fluid in the vaporizer which we approximate by the arithmetic mean between the entrance and exit temperatures. If just enough heat is supplied to completely vaporize the liquid as it passes through the vaporizer, then the total heat transferred must be equal to the heat required to convert liquid to vapor at the exit temperature and pressure.

If the temperature of the heater is higher than the minimum required for steady vaporization, then the necessary heat can be supplied in a length shorter than the length of the heater and vaporization will tend to occur inside the capillary; on the other hand, if insufficient heat is supplied, superheated liquid will emerge and begin to vaporize only after exiting the capillary. From correlation of visual observation of the vaporizer jet in the laboratory with the behavior of the vaporizer installed in the mass spectrometer, it appears that the best performance probably corresponds to nearly complete vaporization occurring a short distance back inside the vaporizer. Since heat is supplied to the liquid primarily by conduction from the walls, the vaporization of the liquid near the axis of the capillary will tend to lag behind that near the walls.

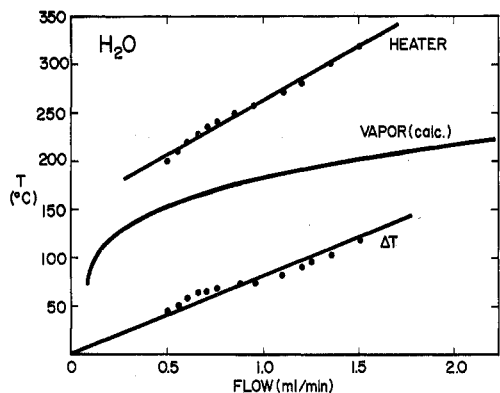

Figure 3. The upper curve (heater) gives the measured temperature of the vaporizer heater block required to produce a fine dry mist when thermospraying water in the laboratory atmosphere. The middle curve gives the calculated vapor temperature according to the steady vaporization model for the 0.015 cm diameter capillary used in this work. The lower curve (ΔT) is the difference between the upper and middle curves and corresponds to the temperature drop in the stainless steel capillary and the solid-liquid interface.

If the nominal liquid-vapor interface is near the exit of the vaporizer, this portion of the liquid emerges as a visible mist entrained in the vapor jet. At slightly higher vaporizer temperatures the mist disappears and a hot, dry, very intense vapor jet emerges from the capillary, presumably with sonic velocity at the exit.

The vaporizer temperature for the best performance in the mass spectrometer can be correlated with the performance of the vaporizer in the laboratory atmosphere. The conditions for maximum ion current production in the mass spectrometer correspond (in the laboratory atmosphere) to the production of a jet containing visible, very fine droplets which produce a visible spot upon striking a room temperature surface but which vaporize on impact leaving no accumulation of liquid on the surface. The vaporizer temperature at which this behavior is observed for water is plotted as a function of flow rate in Figure 3, where it is compared with the calculated vapor temperature by using the steady vaporization model. Also shown in Figure 3 is the difference between the vaporizer temperature and the calculated vapor temperature. This difference is approximately proportional to the flow rate. If we assume that the temperature of the liquid entering the vaporizer is about 30 °C, these results correspond to a thermal resistance of about 3.2 °C/W. The resistance corresponds to a value of the convection coefficient, n , in eq 2 of ca. 7 which implies that about 80% of the thermal resistance is due to the solid-liquid interface. With the thermal resistance of the vaporizer known, the vaporizer temperature necessary to produce steady vaporization of any liquid can readily be calculated.

The efficiency of thermospray ionization is very sensitive to vaporizer conditions. Total ion currents obtained from thermospray ionization of 0.1 M aqueous ammonium acetate measured as a function of vaporizer temperature and flow rate are summarized in Figure 4. These results were obtained by operating the quadrupole with only RF excitation so as to transmit all of the ions and by collecting the ions on a Faraday cup at the quad exit. No external source of ionization was used for these experiments and no electrical fields were employed inside the ion source. These results were obtained for positive ions, but approximately equal intensities of negative ions are also produced and their behavior with temperature and flow rate is similar.

These results correlate well with our visual observations. The maximum current corresponds to production of a relatively dry mist in an intense vapor jet; the temperatures corresponding to the maxima in Figure 4 are in excellent

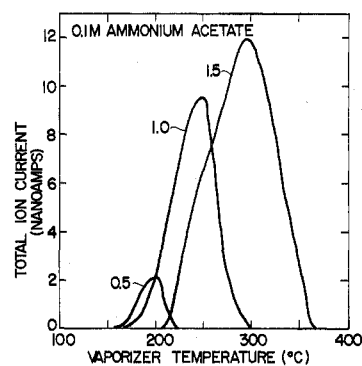

Figure 4. Total ion current produced by thermospray ionization of 0.1 M aqueous ammonium acetate as a function of vaporizer temperature. The flow rates in mL/min are as indicated.

agreement with the optimum temperature vs. flow rate results obtained visually (Figure 3). Also, the temperature at which the current vanishes on the high temperature side correlates with disappearance of the mist, while the low temperature threshold for current production correlates with the minimum temperature for jet formation. Mass spectra obtained by thermospray ionization of aqueous ammonium acetate show that the positive ion spectra consist almost entirely of NH_4^+ and its clusters with water, ammonia, and acetic acid while the negative ion spectra consist of the acetate ion clustered with one or two acetic acid molecules.

Mechanism of Thermospray Ionization. Studies of the mechanism of thermospray ionization are still in progress, but the major features are now fairly well understood (9). Briefly, it appears that the process begins with nearly complete vaporization of the liquid at the rate with which it is supplied to the vaporizer to produce a superheated mist carried in a supersonic jet of vapor. Nonvolatile molecules are preferentially retained in the droplets of the mist. The droplets of the mist are charged positively or negatively according to statistical expectations for random sampling of a neutral fluid containing discrete positive and negative charges as described by Dodd (10). Molecular ions clustered with a few solvent molecules evaporate from the superheated droplets assisted by the high local electrical fields generated by the charge on the droplet. The initially formed cluster ions rapidly equilibrate with the vapor in the ion source to produce the degree of solvation appropriate to the temperature and pressure of the vapor in the source. Ion-molecule reactions will occur if exothermic channels are available. Finally, the ions present in the source diffuse to the sampling aperture and are transmitted to the mass analyzer. While some details of this proposed mechanism remain somewhat speculative at present, all of our observations to date are compatible with it.

Thermospray ionization appears to provide intact molecular ions for any molecule which is ionized in solution and the efficiency of producing these ions seems nearly independent of the molecular weight and volatility of sample. As an example, a spectrum of the tetradecapeptide renin substrate is shown in Figure 5. This is the largest molecule which has been successfully detected by using thermospray ionization to date and is near the upper mass limit of our quadrupole as presently configured. The mass resolution is too low and the mass scale calibration too uncertain in this high mass range to assign with certainty the peaks corresponding approximately to doubly and triply charged ions. From recent results on field desorption of large peptides with multiply ionizable side chains (11), we tentatively suggest that these are probably doubly and triply protonated molecules. Similar results have been obtained on other molecules with molecular weights in excess of 1000 amu including vitamin B_{12} , gramicidin, and several peptides.

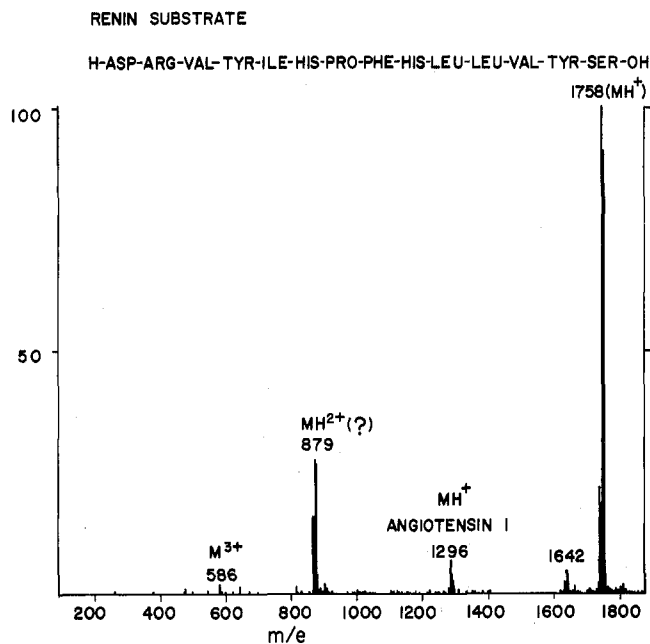

Figure 5. Thermospray ionization mass spectrum of renin substrate obtained from 10 μg injected into 0.1 M ammonium acetate flowing at 1 mL/min. The peak at m/e 1296 is tentatively identified as due to angiotensin I present as an impurity in the sample while the peaks at approximately 879 and 586 are probably due to multiply protonated molecules.

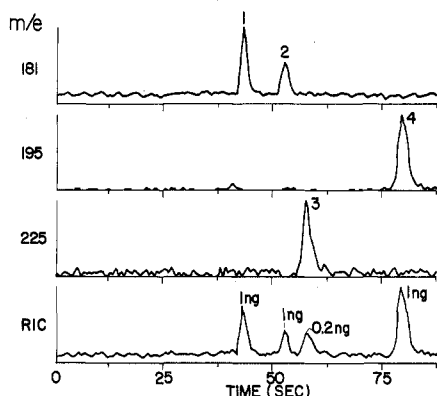

Figure 6. LC/MS analysis of a mixture of xanthine derivatives: 1, theobromine; 2, theophylline; 3, β -hydroxyethyltheophylline; 4, caffeine. Obtained with a 3- μm Ultrasphere (Altex) ODS column and mobile phase consisting of 12% acetonitrile in 0.1 M ammonium acetate at a flow rate of 1.5 mL/min. MS obtained with thermospray ionization of the total LC effluent; sample quantities are indicated on the figure.

We have not succeeded in obtaining molecular ions for large nonvolatile molecules which are neutral in solution; however molecules which are slightly volatile and thermally stable can be ionized by ion-molecule reactions with reagent ions either produced by thermospray from the buffer or by gas-phase processes initiated by electron ionization. The behavior of the system in this operating mode is very similar to that obtained by so-called "desorption chemical ionization" (12, 13).

Performance as a Detector for HPLC. Most of our work on applying the thermospray system to analyses by LC/MS has focused on reversed-phase chromatography with ammonium acetate buffer with either methanol or acetonitrile as organic modifier with flow rates between 1 and 2 mL/min. An example of a chromatogram obtained on a test mixture is shown in Figure 6. Several features of the performance of the system are illustrated by these results. The response is quite dependent on the properties of the sample molecule, and it is not yet possible to predict reliably the relative re-

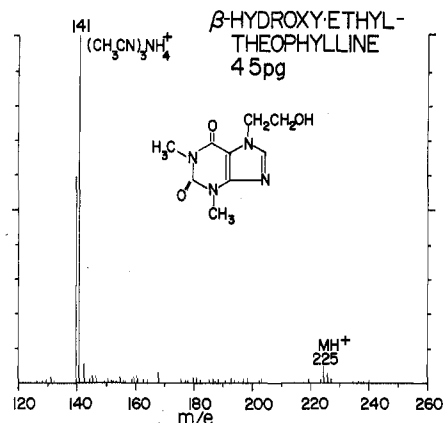

Figure 7. Mass spectrum obtained from 45 pg of β -hydroxyethyltheophylline injected on column. Chromatographic conditions are as given in the preceding figure. Peaks other than the MH^+ ion at m/e 225 are due to the solvent.

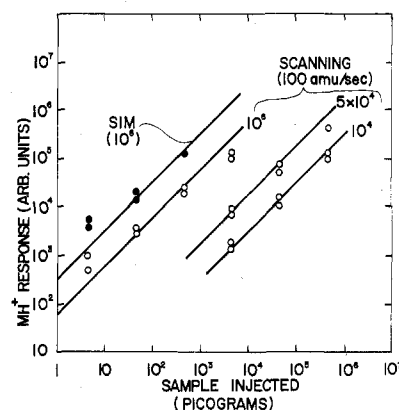

Figure 8. MH^+ response as a function of sample of β -hydroxyethyltheophylline injected. The parameter labeling the lines corresponding to the expected linear response is the approximate electron multiplier gain used.

sponse of similar molecules. For example, the sensitivity for β -hydroxyethyltheophylline is about five times that for theophylline.

The peaks in the chromatogram shown in Figure 6 are between 2 and 3 s wide FWHM; the caffeine peak corresponds to an overall efficiency of about 10^4 theoretical plates. Any contribution to band broadening by the mass spectrometer is undetectable. Regular oscillations in the background intensity, for example at m/e 181, which occurs with a period of about 3.5 s are due to flow fluctuations introduced by the HPLC pump. These oscillations in flow are only about 2% of the nominal flow but because of the strong dependence of ion intensities on liquid flow rate these oscillations are amplified to about 20% in the signal. At present this oscillation due to flow fluctuation is primarily responsible for setting the noise level.

A typical spectrum for one of these test compounds at trace levels is shown in Figure 7. In this example, the MH^+ ion intensity produced by an injection of 45 pg is the largest peak above m/e 141. The integrated response at MH^+ (m/e 225) is shown as a function of sample injected on column in Figure 8. Duplicate measurements were run on each sample; where only a single point is shown the difference between the two results was smaller than the width of the dot used in the plot. The detection limit ($S/N = 2$) is about 5 pg both for SIM and for full scans and the mean difference in response between duplicate runs is approximately 20%. Both short-term reproducibility and detection limit are primarily set by pump induced flow fluctuations. By changing the multiplier gain to avoid saturation of the amplifier, the response is linear over

6 orders of magnitude from the low picogram to the low microgram range.

The development of the thermospray technique has reached the point that it appears to be a useful analytical tool both for producing spectra of nonvolatile, thermally labile molecules and for use in an on-line LC/MS system. Results similar to those presented here have been obtained for a variety of other classes of compounds including amino acids, small peptides, nucleosides, and antibiotics. Despite these successes, some additional research is required to develop a system which is routinely applicable to a broad range of analytical problems. Many details of the mechanism of ionization are not yet well understood and the optimum configuration of the vaporizer and ion sampling have not yet been established. Major limitations on the technique at present are the difficulties with day-to-day reproducibility of ionization efficiency and fragmentation patterns and the rather severe dependence of the ion intensities on the liquid flow.

ACKNOWLEDGMENT

We thank C. R. Hsieh for preparing the figures for publi-

cation and H.-Y. Kim for assistance in obtaining some of the data presented.

LITERATURE CITED

- (1) Arpino, P. J.; Gulchon, G. *Anal. Chem.* **1979**, *51*, 682A.
- (2) McFadden, W. H. *J. Chromatogr. Sci.* **1979**, *17*, 2.
- (3) Arpino, P. J. *Trends Anal. Chem.* **1982**, *1*, 154.
- (4) Arpino, P. J. *Biomed. Mass Spectrom.* **1982**, *9*, 176.
- (5) Blakley, C. R.; McAdams, M. J.; Vestal, M. L. *J. Chromatogr.* **1978**, *158*, 261.
- (6) Blakley, C. R.; Carmody, J. J.; Vestal, M. L. *Anal. Chem.* **1980**, *52*, 1636.
- (7) Blakley, C. R.; Carmody, J. J.; Vestal, M. L. *J. Am. Chem. Soc.* **1980**, *102*, 5931.
- (8) Sissom, L. E.; Pitts, D. R. "Elements of Transport Phenomena"; McGraw-Hill: New York, 1972; pp 488-496 and 673-675.
- (9) Vestal, M. L. *Int. J. Mass Spectrom. Ion Phys.* **1983**, *46*, 193.
- (10) Dodd, E. E. *J. Appl. Phys.* **1953**, *24*, 73.
- (11) Katakuse, I.; Matsuo, T.; Wollnik, H.; Matsuda, H. *Org. Mass Spectrom.* **1979**, *14*, 457.
- (12) Cotter, R. J. *Anal. Chem.* **1980**, *52*, 1589A.
- (13) Carroll, D. I.; Nowlin, J. G.; Stillwell, R. N.; Horning, E. C. *Anal. Chem.* **1981**, *53*, 2007.

RECEIVED for review October 12, 1982. Accepted December 13, 1982. This work was supported by the Institute of the General Medical Sciences (NIH) under Grant GM 24031.

Nitrous Oxide as Reagent Gas for Positive Ion Chemical Ionization Mass Spectrometry

Charles W. Polley, Jr., and Burnaby Munson*

Department of Chemistry, University of Delaware, Newark, Delaware 19711

Nitrous oxide may be an analytically useful chemical ionization reagent gas for positive ion as well as negative ion analyses. The low-energy NO⁺ ion frequently gives M⁺ or (M + NO)⁺ ions for molecular weight determination. The higher energy N₂O⁺ ion gives significant amounts of fragmentation from dissociative charge exchange with aliphatic systems.

Nitrous oxide, N₂O, has the potential of being a very useful reagent gas in chemical ionization mass spectrometry (CIMS). Its use in mixtures with hydrocarbons to produce OH⁻ for negative CIMS has been demonstrated (1-4). Nitrous oxide is somewhat unusual as a reagent gas in that reactions occur between negative ions from the sample and N₂O (1). Reactions of O⁻ ions from N₂O have also been studied with organic compounds (5, 6). Little work has been reported on the positive ion chemistry of N₂O with complex organic molecules. It has been reported that NO⁺ and N₂O⁺ were stable in N₂O at usual CI pressures, although some clustering is observed at high pressures (7, 8). Since the ionization energy of N₂O is 12.9 eV and IE(NO) = 9.27 eV (9) there is an energetic reactant ion, N₂O⁺, which can produce structurally useful fragment ions and a low energy ion, NO⁺, which may give ions in the molecular weight range from hydride or electron transfer reactions. Nitrous oxide, then, may give CI spectra similar to those obtained previously with N₂/NO mixtures (10, 11) without the complications of handling NO mixtures. In addition, these may be reactions of positive ions with N₂O analogous to the reactions with negative ion reported previously (1).

EXPERIMENTAL SECTION

The majority of these spectra were obtained with a CEC (Du Pont) 21-110B mass spectrometer which has been described previously (12, 13). The compounds used in these experiments were obtained from several commercial sources and were used without further purification. The nitrous oxide and nitrogen/10% nitric oxide mixtures were obtained from Matheson, East Rutherford, NJ. The volatile liquids were introduced into the hot (200-250 °C) mass spectrometer source from a conventional heated oven or from a gas chromatograph. Solid samples were vaporized into the source from a glass capillary in the well of a separately heatable glass probe. N₂O and N₂/10% NO CI spectra were obtained at 0.5 ± 0.1 torr and an electron energy of approximately 600 eV. The precision in the relative abundances of ions in the spectra is ±20%. Electron ionization (EI) spectra were obtained with conventional low pressure sources.

The major fragment ions of N₂O (N₂⁺, N⁺, and O⁺) react rapidly with N₂O. The dominant ions in the high-pressure spectra of N₂O are NO⁺ (33% of ionization) and N₂O⁺ (63% of ionization). The relative abundances of these two ions are essentially constant from about 0.1 torr to the highest pressure used, 0.6 torr. Small, variable abundances were noted for an ion of m/z = 45, presumably HN₂O⁺ formed from reaction of N₂O⁺ with ever present traces of water or with the samples. The association ions, NO⁺·N₂O and N₂O⁺·N₂O were not detected at the high temperatures of these experiments. These observations are in agreement with earlier reports for large negative temperature coefficients for the formation of these cluster ions (8). The ratio, NO⁺/N₂⁺, in the N₂/10% NO mixtures was approximately 3.

RESULTS AND DISCUSSION

Spectra were obtained for several classes of compounds with N₂O and N₂/10% NO as the reagent gases for comparison with